

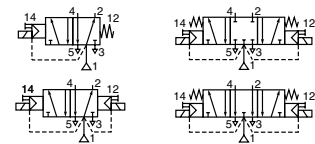

SOLENOID VALVES

pilot operated, spool type
single/dual solenoid (mono/bistable function, W1/W3)
aluminium body, 1/4 - 1/2



5/2

5/3

Series

551-553

FEATURES

- The monostable spool valves in conformity with IEC 61508 Standard (2010 route 2_H version) have TÜV (551 series) and EXIDA (551-553 series) certified with integrity levels: SIL 2 for HFT = 0 / SIL 3 for HFT = 1
- The spool valves 5/2 and 5/3 have threaded port connections
- All the exhaust ports of this spool valve are connectable, providing better environmental protection, particularly recommended for sensitive areas such as clean rooms, and applications in the pharmaceutical and food processing sectors
- The valve offers environmental protection against the ingress of liquids, dusts or any other foreign matter (environmentally-protected construction)
- Can be externally piloted (external air pilot supply) to convert valve to zero minimum operation by flipping a gasket
- The solenoid valves satisfy all relevant EC Directives

GENERAL

Differential pressure 2 - 10,4 bar [1 bar = 100 kPa]
Flow (Qv at 6 bar) 1/4 = 860 l/min (5/2) ; 760l/min (5/3) (ANR)
1/2 = 3800 l/min (5/2, 5/3)

fluids (*)	temperature range (TS)	seal materials (*)
air, inert gas, filtered	- 25°C to + 60°C	NBR (nitrile) + PUR (polyurethane)

MATERIALS IN CONTACT WITH FLUID

(*) Ensure that the compatibility of the fluids in contact with the materials is verified

Body	Aluminium, black anodized
End cover (spring)	Glass-filled PA
Spool valve internal parts	Zamak, stainless steel, (POM), aluminium
Pilot internal parts	Refer to specific solenoid catalogue pages
Pilot end covers	Aluminium
Core tube	Stainless steel
Core and plugnut	Stainless steel
Core spring	Stainless steel
Seals	NBR
Top disc	PA
Disc holder	POM
Cartridge (low power)	Welded, packless AISI 430
Seat	Brass
Seat insert	POM
Shading coil	Copper
Rider rings (low power)	PTFE (NF/WSNF solenoids only)

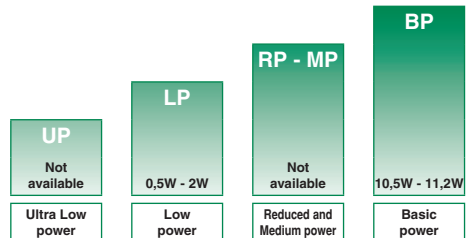
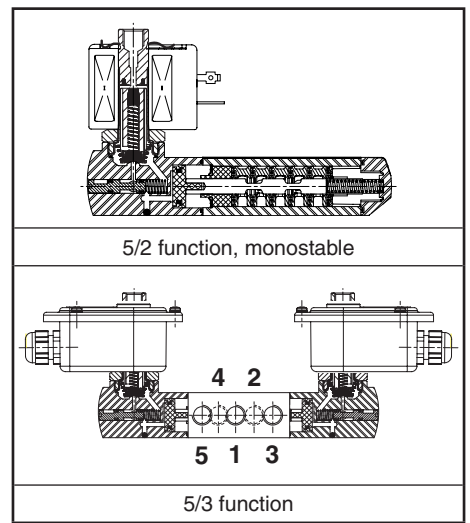

POWER LEVELS - cold electrical holding values (watt)

SPECIFICATIONS

pipe size	orifice size	flow coefficient kv		operating pressure differential (bar)		power level	prefix optional solenoids								basic catalogue number	
				min. ⁽³⁾	max. (PS)		ATEX / IECEx					IP65				
							air (*)		Ex d	Ex e mb	Ex mb		Ex ia	-		
(*)	(mm)	(m ³ /h)	(l/min)	~	=	~/=	EF	(WS)LPKF	NF	EM	PV	(WS)LI	-	SC		
5/2 - Solenoid air pilot operated - spring return (monostable)																
1/4	6	0,75	12,5	0/2	10	10	BP	-	-	●	●	●	-	-	●	❖551B417 ⁽²⁾
1/4	6	0,75	12,5	0/2	10	10	BP	●	-	-	-	-	-	-	-	❖551H417 ⁽²⁾
1/4	6	0,75	12,5	0/2	10	10	LP	-	●	●	●	○	○	-	●	❖551B317 ⁽²⁾
1/4	6	0,75	12,5	0/2	10	10	LP	○	-	-	-	-	-	-	-	❖551H317 ⁽²⁾
1/2	13	3,15	52,5	0/2	10	10	BP	-	-	●	●	●	-	-	-	❖553A417 ⁽²⁾
1/2	13	3,15	52,5	0/2	10	10	BP	●	-	-	-	-	-	-	-	❖553G417 ⁽²⁾
1/2	13	3,15	52,5	0/2	10	10	LP	-	●	●	●	○	○	-	●	❖553A317 ⁽²⁾
1/2	13	3,15	52,5	0/2	10	10	LP	○	-	-	-	-	-	-	-	❖553G317 ⁽²⁾

❖ Select 8 for NPT ANSI 1.20.3 or select G for ISO G (228/1) ● Available feature ○ Available feature in DC only - Not available
(2) Certified IEC 61508 Functional Safety data, use suffix "SL"
(3) Zero minimum is only achieved if external pressure is applied.



Global Supply Line are ASCO distributors and keep large stocks of ASCO products, such as solenoid valves. Contact us for any inquiries within Australia. Contact us at sales@globalsupplyline.com.au Visit our website www.globalsupplyline.com.au

SPECIFICATIONS

pipe size	orifice size	flow coefficient kv		operating pressure differential (bar)			power level	prefix optional solenoids								basic catalogue number
				min. ⁽³⁾	max. (PS)			NEMA 7 & 9	ATEX / IECEx					IP65		
					air (*)				Ex d	Ex e mb	Ex mb	Ex ia	-			
(*)	(mm)	(m ³ /h)	(l/min)	~	=	~/=	EF	(WS)LPKF	NF	EM	PV	(WS)LI	-	SC		
5/2 - Solenoid air pilot operated and return (bistable)																
1/4	6	0,75	12,5	0/2	10	10	BP	-	-	●	●	●	-	-	●	❖551B418
1/4	6	0,75	12,5	0/2	10	10	BP	●	-	-	-	-	-	-	-	❖551H418
1/4	6	0,75	12,5	0/2	10	10	LP	-	●	●	●	○	○	-	-	❖551B318
1/4	6	0,75	12,5	0/2	10	10	LP	○	-	-	-	-	-	-	-	❖551H318
1/2	13	3,15	52,5	0/2	10	10	BP	-	-	●	●	●	-	-	●	❖553A418
1/2	13	3,15	52,5	0/2	10	10	BP	●	-	-	-	-	-	-	-	❖553G418
1/2	13	3,15	52,5	0/2	10	10	LP	-	●	●	●	○	○	-	●	❖553A318
1/2	13	3,15	52,5	0/2	10	10	LP	○	-	-	-	-	-	-	-	❖553G318
5/3 - W1 - pressure held, solenoid air pilot operated and return																
1/4	6	0,66	11	0/2	10	10	BP	-	-	●	●	●	-	-	●	❖551B467
1/4	6	0,66	11	0/2	10	10	BP	●	-	-	-	-	-	-	-	❖551H467
1/4	6	0,66	11	0/2	10	10	LP	-	●	●	●	○	○	-	●	❖551B367
1/4	6	0,66	11	0/2	10	10	LP	○	-	-	-	-	-	-	-	❖551H367
1/2	13	3,15	52,5	0/2	10	10	BP	-	-	●	●	●	-	-	●	❖553A467
1/2	13	3,15	52,5	0/2	10	10	BP	●	-	-	-	-	-	-	-	❖553G467
1/2	13	3,15	52,5	0/2	10	10	LP	-	●	●	●	○	○	-	●	❖553A367
1/2	13	3,15	52,5	0/2	10	10	LP	○	-	-	-	-	-	-	-	❖553G367
5/3 - W3 - pressure release, solenoid air pilot operated and return																
1/4	6	0,66	11	0/2	10	10	BP	-	-	●	●	●	-	-	●	❖551B468
1/4	6	0,66	11	0/2	10	10	BP	●	-	-	-	-	-	-	-	❖551H468
1/4	6	0,66	11	0/2	10	10	LP	-	●	●	●	○	○	-	●	❖551B368
1/4	6	0,66	11	0/2	10	10	LP	○	-	-	-	-	-	-	-	❖551H368
1/2	13	3,15	52,5	0/2	10	10	BP	-	-	●	●	●	-	-	●	❖553A468
1/2	13	3,15	52,5	0/2	10	10	BP	●	-	-	-	-	-	-	-	❖553G468
1/2	13	3,15	52,5	0/2	10	10	LP	-	●	●	●	○	○	-	●	❖553A368
1/2	13	3,15	52,5	0/2	10	10	LP	○	-	-	-	-	-	-	-	❖553G368

 ❖ Select **8** for NPT ANSI 1.20.3 or select **G** for ISO G (228/1) ● Available feature ○ Available feature in DC only - Not available

(3) Zero minimum is only achieved if external pressure is applied.

PREFIX TABLE

prefix							description	power level			
1	2	3	4	5	6	7		LP	RP	MP	BP
E	F						Explosionproof - NEMA 7, 9 - Zinc plated steel conduit	○	-	-	●
E	M						Waterproof IP67 - Metal enclosure (EN/IEC 60079-7+18, 61241-1)*	●	-	-	●
L	P	E	T				Threaded conduit/hole (M20 x 1,5)	●	-	-	●
N	F	K	F				Flameproof - Aluminium (EN/IEC 60079-1, 60079-31)*	●	-	-	●
P	V						Flameproof - Aluminium (EN/IEC 60079-1, 61241-1)*	●	-	-	●
S	C						Encapsulated epoxy moulded (EN/IEC 60079-18, 61241-18)*	○	-	-	●
W	P						Solenoid with spade plug connector (EN/IEC 60730)	●	-	-	●
L	I						Waterproof IP67 - Metal enclosure	●	-	-	●
W	S						I.S. with Aluminium IP67 enclosure (EN/IEC 60079-11 / 60079-31)*	○	-	-	●
W	S	L	P	K	F		Waterproof IP67 - 316 SS enclosure	●	-	-	●
W	S	E	M				Flameproof - 316 SS (EN/IEC 60079-1, 60079-31)*	●	-	-	●
W	S						Waterproof IP67 - 316 SS enclosure (EN/IEC 60079-7+18, 61241-1)*	●	-	-	●
W	S	N	F	L	I		I.S. with 316L SS IP67 enclosure (EN/IEC 60079-11, 60079-31)*	○	-	-	●
W	S	T					Flameproof - 316L SS (EN/IEC 60079-1, 60079-31)*	●	-	-	●
				H	T		Threaded conduit (1/2" NPT)	●	-	-	●
						X	Class H - High temperature (ambient +80°C)	-	-	-	●
							Other special constructions	●	-	-	●

SUFFIX TABLE

suffix					description	power level			
1	2	3	4	5		LP	RP	MP	BP
	S	L	M	O	Push type manual operator	●	-	-	●
	M	F			Certified IEC 61508 Functional Safety data ⁽¹⁾	●	-	-	●
					Low temperature -40°C	●	-	-	●

- * ATEX solenoids are also approved according to EN 13463-1 (non electrical valves)
- Available feature
- Available feature in DC only
- Not available
- ⁽¹⁾ Not to use with MO suffix

PRODUCT SELECTION GUIDE

STEP 1

Select the fluid temperature range and seal material from the general table on page 7. Select basic catalogue number, including pipe thread identification letter. Refer to the specifications tables on pages 7 and 8.

Example : G553A417

STEP 2

Select prefix (combination). Select the appropriate operator from the specifications table on page 7 and the prefix table on page 8. Select for this operator in the electrical characteristics table on page 10: the power level (LP, BP), the type of electrical enclosure protection and the desired temperature class.

Warning: The ambient temperature range of your application may not exceed the temperature range of your operator.

Example : EM

STEP 3

Select suffix (combination) if required.

Example : MO

STEP 4

Select voltage. Refer to standard voltages on page 10.

Example : 230V / 50Hz

STEP 5

Final catalogue / ordering number.

Example :

EM G553A417MO 230 V / 50 Hz

OPTIONS & ACCESSORIES

series	pipe size	exhaust protector (stainless steel)		
		(G)	(NPT)	(M)
551/553	1/8	34600418 ⁽²⁾	34600482 ⁽²⁾	-
551	1/4	34600419 ⁽²⁾	34600483 ⁽²⁾	-
553	1/2	34600479 ⁽²⁾	34600481 ⁽²⁾	-
551	M5	-	-	34600484 ⁽²⁾

⁽²⁾ Provided with "SL" suffix.

ORDERING EXAMPLES:

SC	G	551	B	417	230V / 50 Hz
SC	G	551	B	417	SL 230V / 50 Hz
SC	G	551	B	418	MO 230V / 50 Hz
SCHT	8	551	B	418	MO 230V / 50 Hz
LPKF	G	551	B	317	MO 24V / DC
LPKF	G	551	B	317	MO 230V / 50 Hz
WSLPKF	G	551	B	317	MO 24V / DC
LI	G	553	A	317	24V / DC
EM	8	553	A	418	MO 230V / 50 Hz
EF	G	551	H	417	MO 240V / 60 Hz

prefix ⁽³⁾ pipe thread voltage suffix

⁽³⁾ Prefixes EF should always be used with the letter H or G in the basic number.

EXPLANATION OF TEMPERATURE RANGES OF SOLENOID VALVES

Valve temperature range	The valve temperature range (TS) is determined by the selected seal material, the temperature range for proper operation of the valve and sometimes by the fluid (e.g. steam)
Operator ambient temperature range	The operator ambient temperature range is determined by the selected power level and the safety code
Total temperature range	The temperature range of the complete solenoid valve is determined by the limitations of both temperature ranges above

ELECTRICAL CHARACTERISTICS

Coil insulation class F
 Electrical safety IEC 335
 Standard voltages DC (=) 24V - 48V
 AC (~) 24V - 48V - 115V - 230V⁽⁵⁾/50Hz; other voltages and 60Hz are available on request

prefix option	power ratings				operator ambient temperature range (TS) (C°) ⁽¹⁾	safety code	electrical enclosure protection (EN 60529)	replacement coil / kit		type ⁽²⁾
	inrush	holding	hot/cold	=				~	=	
	(VA)	(VA)	(W)	(W)				230 V/50 Hz	24V/DC	
Basic power (BP)										
SC	55	23	10,5	9/11,2	-40 to +75	EN 60730	IP65 moulded	400425-117	400425-142	01
WP/WS	55	23	10,5	9/11,2	-40 to +75	EN 60730	IP67 steel/SS	400405-117	400405-142	04
NF/WSNF	55	23	10,5	-	(-60) ⁽⁷⁾ -40 to +25/40/60	II2G Ex d IIC T6/T5/T4, II2D Ex t	IP67 alum./SS	400405-117	-	02
NF/WSNF	-	-	-	9/11,2	(-60) ⁽⁷⁾ -40 to +40/60/75	II2G Ex d IIC T6/T5/T4, II2D Ex t	IP67 alum./SS	-	400405-142	02
EM/WSEM	55	23	10,5	9/11,2	-40 to +40	II2G Ex e mb II T3, II2D Ex tD	IP67 steel/SS	400909-117	400913-142	04
PV	55	23	10,5	9/11,2	-40 to +65	II2G Ex mb II T3(-)/T4(=), II2D Ex mD 21	IP67 moulded	- ⁽⁴⁾	- ⁽⁴⁾	05
EF	55	23	10,5	9/11,2	-40 to +54/40	NEMA type 7 and 9	NEMA 4X	238614-058	238714-006	06
Low power (LP)										
SC	1,5	1,5	1,5	1,7/1,7	-40 to +60	EN 60730	IP65 moulded	400925-097	400925-042	07
WP/WS	1,5	1,5	1,5	1,7/1,7	-40 to +60	EN 60730	IP67 steel/SS	400926-097	400926-042	09
LPKF/WSLPKF ⁽⁸⁾	2,4	2,4	2,4	0,5/0,5 ⁽⁸⁾	-40 to +80/60	II2G Ex d IIB+H2 Gb T4/T6, II2D Ex t Db	IP67 alum./SS	- ⁽⁴⁾	- ⁽⁴⁾	13
NF/WSNF	-	-	1,85	-/1,8	(-60) ⁽⁷⁾ -40 to +75/80	II2G Ex d IIC T6/T5, II2D Ex t	IP67 alum./SS	- ⁽⁴⁾ ⁽⁵⁾	- ⁽⁴⁾	08
EM/WSEM	1,5	1,5	1,5	1,7/1,7	-40 to +40/55	II2G Ex e mb II T6/T5, II2D Ex tD	IP67 steel/SS	- ⁽⁴⁾	- ⁽⁴⁾	09
PV	-	-	-	1,7/1,7	-40 to +65	II2G Ex mb II T6 / II2D Ex mD 21	IP67 moulded	-	- ⁽⁴⁾	10
EF	-	-	-	1,7/1,7	-40 to +60	NEMA type 7 and 9	NEMA 4X	-	- ⁽⁴⁾	11
LI ⁽³⁾ ⁽⁶⁾	-	-	-	0,5/0,5	-40 to +60	II1G Ex ia IIC T6 Ga, II2D Ex t IIIC Db ⁽⁶⁾	IP67 alum.	-	- ⁽⁴⁾	14
WSLI ⁽³⁾ ⁽⁶⁾	-	-	-	0,5/0,5	-40 to +60	II1G Ex ia IIC T6 Ga, II2D Ex t IIIC Db ⁽⁶⁾	IP67 SS	-	- ⁽⁴⁾	14

prefix option	safety parameters				
	U _i = (DC) (V)	I _i (mA)	P _i (W)	L _i (H)	C _i (µF)
Low power (LP)					
LI/WSLI	32	500	1,5	0	0

- ⁽¹⁾ Temperature range can be limited by sealings
- ⁽²⁾ Refer to the dimensional drawings on pages: 11 to 14
- ⁽³⁾ LI/WSLI: Check the electrical characteristics in the corresponding catalogue pages
- ⁽⁴⁾ Multiple coil kits are available under ATEX/IECEX, contact us
- ⁽⁵⁾ (WS)NF: Low Power, 230 V AC does not exist. Maximum voltage in AC is 115 V
- ⁽⁶⁾ LI/WSLI: Low Power, 24 V DC only (**For use in zone 0 locations, see the installation conditions given in the I&M instructions**)
- ⁽⁷⁾ The certified minimum temperature of this operator
- ⁽⁸⁾ LPKF/WSLPKF: 24 V DC, max. ambient temp. +80°C, contact us (48 V DC = 2,1 W)
- Not available

ELECTRICAL CONNECTIONS

prefix	connection
SC	Spade plug connector with cable gland EN175301-803A (ISO 4400) for cables with an outer diameter from 6 to 10 mm
WP, WS, EM, WSEM	M20 cable gland for cables with an outer diameter from 7 to 12 mm. With an internal and external facility for an earthing or bonding conductor
NF, WSNF, LPKF, WSLPKF	1/2" NPT threaded cable entry. Enclosures are supplied without cable gland
PV	Moulded-in cable, standard length 2 m
LI, WSLI	1/2" NPT cable gland for cables with an outer diameter from 7 to 12 mm. With an internal and external facility for an earthing or bonding conductor
EF	1/2" NPT conduits, standard length 35 cm

ADDITIONAL OPTIONS

- Valves configured for external pilot air supply, TPL 20547
- Other pipe threads are available on request
- Ex mb/mD (prefix "PV") solenoid can be supplied with various cable lengths
- Compliance with "UL", "CSA" and other local approvals available on request
- 1/2" NPT (prefix "T") and M20 x 1.5 (prefix "ET") conduits (aluminium or 316 SS) available for steel solenoid housing

INSTALLATION

- Multi language installation/maintenance instructions are included with each valve
- The solenoid valves can be mounted in any position without affecting operation
- Do not connect the pressure supply to the exhaust port 3. The "environmentally-protected" construction is not adapted for a "distributing" function or use in NO function. Contact us for functions available in specific versions
- IEC 61508 Functional Safety (suffix SL). Check temperature range of valve body and solenoid for suitability. For probability of failure, contact us
- It is necessary to connect pipes or fittings to the exhaust ports to protect the internal parts of the spool valve and its pneumatic operator if used outside or in harsh environments (dusts, liquids etc.)
- Threaded pipe connection identifier is: 8 = NPT (ANSI 1.20.3); G = G (ISO 228/1)
- Prefix "NF/WSNF" enclosure is provided with a 1/2" NPT threaded entry hole, M20 x 1,5 (prefix "ET") is optional. Both are supplied without cable gland
- To comply with IEC 61508 (SIL) the valves must be provided with a specific exhaust protector (see following pages)

DIMENSIONS (mm), WEIGHT (kg)

Series 551

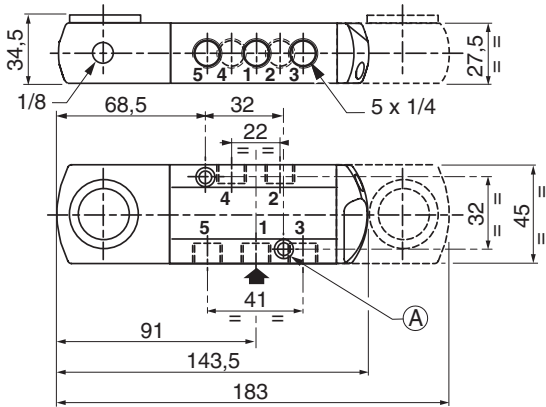

Series 553

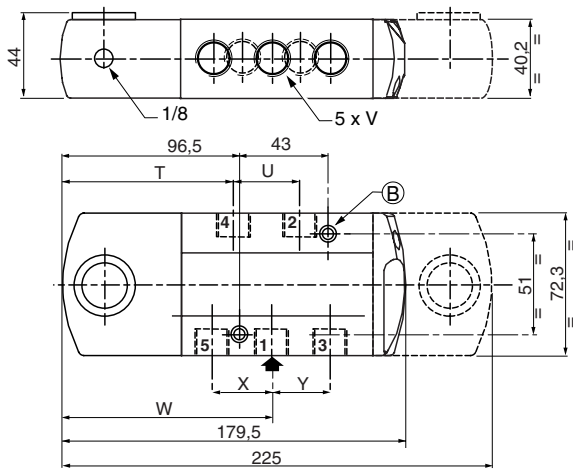

- (A) 2 mounting holes dia. 5,3; Spotfacing: dia. 9, depth 5 mm
- (B) 2 mounting holes dia. 6,5; Spotfacing: dia. 11, depth 6 mm

	type	T	U	V	W	X	Y
553	01 to 11	93	31,6	1/2	112,5	31,6	31,8
	12 to 19	75	31,6	1/2	94,5	31,6	31,8

DIMENSIONS (mm), WEIGHT (kg)



TYPE 01:
SC
Epoxy moulded
IEC 335 / ISO 440

551B417/B418/B417MO/B418MO/B467/B468/B467MO/B468MO
553A417/A418/A417MO/A418MO/A467/A468/A467MO/A468MO

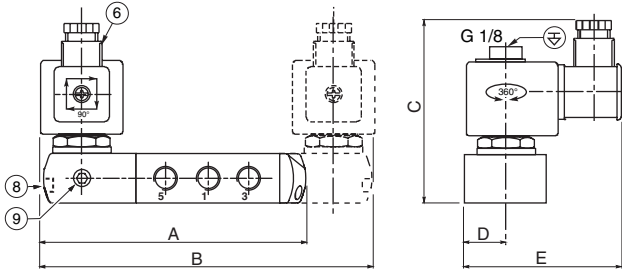

TYPE 02:
NF / WSNF
Aluminium; epoxy coated / AISI 316L SS
EN/IEC 60079-1 and EN/IEC 60079-31

551B417/B418/B417MO/B418MO/B467/B468/B467MO/B468MO
553A417/A418/A417MO/A418MO/A467/A468/A467MO/A468MO

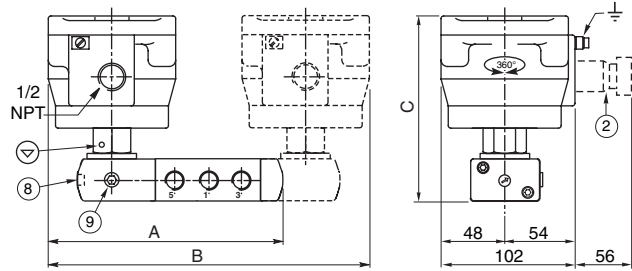

TYPE 04:
WP / WS
EM / WSEM
Steel; epoxy coated / AISI 316 SS
IEC 335 / EN 60079-7/18 and EN 61241-1

551B417/B418/B417MO/B418MO/B467/B468/B467MO/B468MO
553A417/A418/A417MO/A418MO/A467/A468/A467MO/A468MO

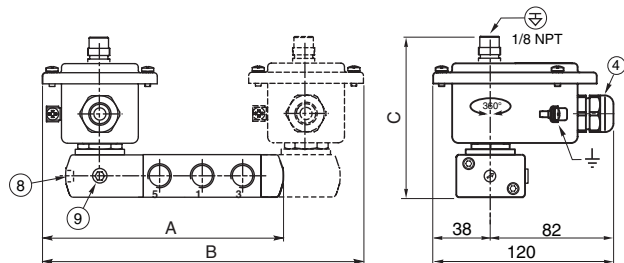

TYPE 05:
PV
Epoxy encapsulated
EN/IEC 60079-18 and EN/IEC 61241-18

551B417/B418/B417MO/B418MO/B467/B468/B467MO/B468MO
553A417/A418/A417MO/A418MO/A467/A468/A467MO/A468MO

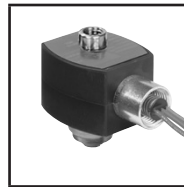
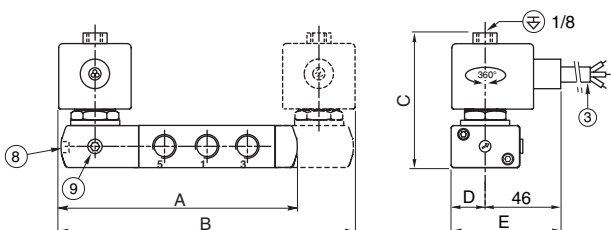

TYPE 06:
EF: NEMA type 7 and 9
Epoxy encapsulated
ICS-6 ANSI
NOTE: applicable to solenoid only

551H417/H418/H417MO/H418MO/H467/H468/H467MO/H468MO
553G417/G418/G417MO/G418MO/G467/G468/G467MO/G468MO

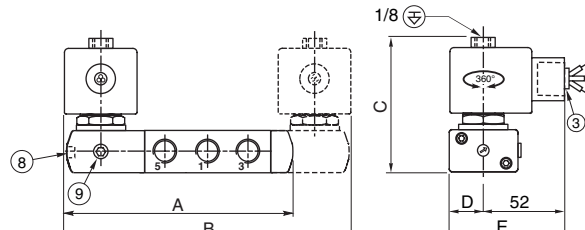

DIMENSIONS (mm), WEIGHT (kg)



TYPE 07:
SC
Epoxy moulded
IEC 335 / ISO 4400

551B317/B318/B317MO/B318MO/B367/B368/B367MO/B368MO
553A317/A318/A317MO/A318MO/A367/A368/A367MO/A368MO

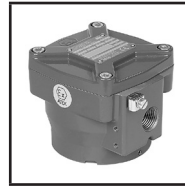
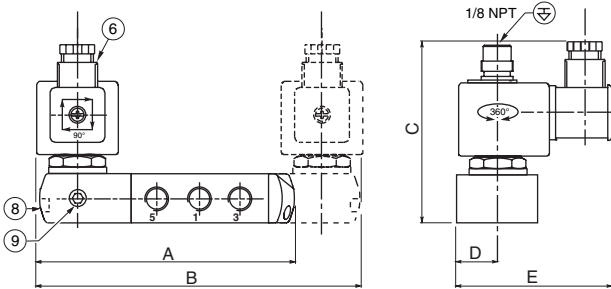

TYPE 08:
NF / WSNF
Aluminium; epoxy coated / AISI 316L SS
EN/IEC 60079-1 and EN/IEC 60079-31

551B317/B318/B317MO/B318MO/B367/B368/B367MO/B368MO
553A317/A318/A317MO/A318MO/A367/A368/A367MO/A368MO

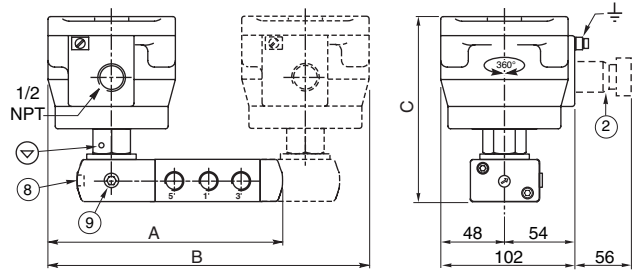

TYPE 09:
WP / WS
EM / WSEM
Steel; epoxy coated / AISI 316 SS
IEC 335/EN 60079-7/18 and EN 61241-1

551B317/B318/B317MO/B318MO/B367/B368/B367MO/B368MO
553A317/A318/A317MO/A318MO/A367/A368/A367MO/A368MO

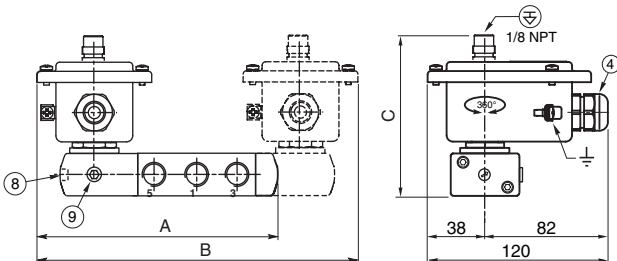

TYPE 10:
PV
Epoxy encapsulated
EN/IEC 60079-18 and EN/IEC 61241-18

551B317/B318/B317MO/B318MO/B367/B368/B367MO/B368MO
553A317/A318/A317MO/A318MO/A367/A368/A367MO/A368MO

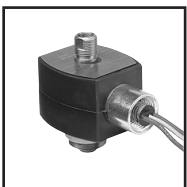
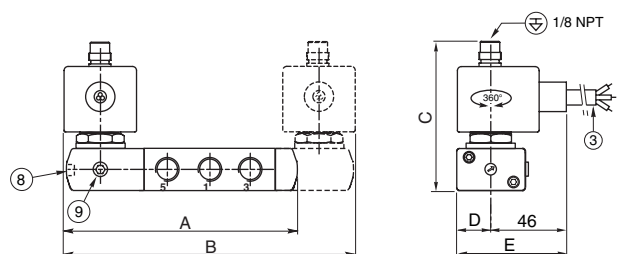

TYPE 11:
EF: NEMA type 7 and 9
Epoxy encapsulated
ICS-6 ANSI
NOTE: applicable to solenoid only

551B317/B318/B317MO/B318MO/B367/B368/B367MO/B368MO
553A317/A318/A317MO/A318MO/A367/A368/A367MO/A368MO

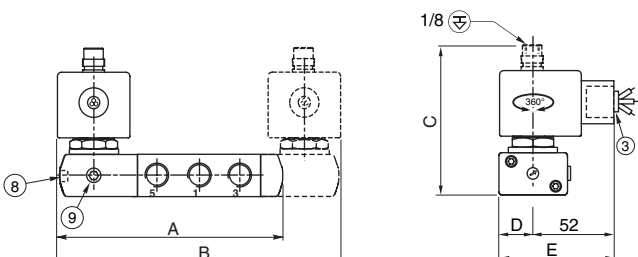

DIMENSIONS (mm), WEIGHT (kg)



TYPE 13:
LPKF / WSLPKF
Aluminium, cataphoresis black painting / AISI 316L SS
EN/IEC 60079-1 and EN/IEC 60079-31



TYPE 14:
LI / WSLI
Aluminium, cataphoresis black painting / AISI 316L SS
EN/IEC 60079-11 and EN/IEC 60079-31

551B317/B318/B317MO/B318MO/B367/B368/B367MO/B368MO
553A317/A318/A317MO/A318MO/A367/A368/A367MO/A368MO

551B317/B318/B317MO/B318MO/B367/B368/B367MO/B368MO
553A317/A318/A317MO/A318MO/A367/A368/A367MO/A368MO

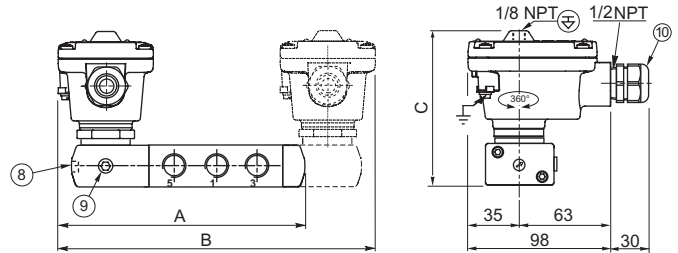
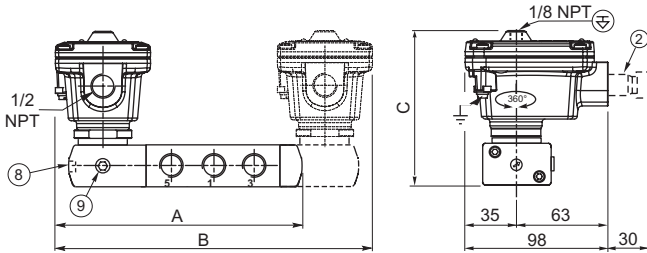

- ② Ex d certified cable gland (on request)
- ③ Three-core cable, length 2 m
- ④ Cable gland for unarmoured cable with 7 to 12 mm dia. sheath
- ⑥ Connector rotatable by 90° increments, cable Ø 6 - 10 mm
- ⑧ Push type or screw type manual operator, suffix MO

- ⑨ External pilot air supply, 1/8 pipe size
- ⑩ Cable gland for unarmoured cable with 7 to 12 mm dia. sheath
- ⊕ Connectable pilot exhaust port
- ⊖ Non-connectable pilot exhaust port

type	prefix option	power level	A		B		C		D		E		weight ⁽¹⁾			
			551	553	551	553	551	553	551	553	551	553	monostable		5/2 bistable - 5/3	
			551	553	551	553	551	553	551	553	551	553	551	553	551	553
01	SC	BP	144	179,5	182	225	102,7	112,2	22,5	36,15	86,5	100,2	0,79	1,50	1,37	2,06
02	NF / WSNF	BP	170	224,3	236	314,6	141,8	151,3	-	-	-	-	1,88	2,54	3,54	4,20
04	WP / WS	BP	160	196,2	216	253,3	103	112,5	-	-	-	-	0,87	1,51	1,52	2,08
04	(WS)EM	BP	160	196,2	216	253,3	103	112,5	-	-	-	-	0,87	1,51	1,52	2,08
05	PV	BP	144	179,5	184	225	88	97,5	22,5	36,15	67,5	81,2	0,85	1,51	1,48	2,07
06	EF	BP	144,5	183	185	232	85,5	95	22,5	36,15	74,5	88,2	0,67	1,51	1,32	2,08
07	SC	LP	144,5	180,5	185	227	101,5	111	22,5	36,15	87,5	101,2	1,00	1,71	1,58	2,27
08	NF / WSNF	LP	170	224,3	236	314,6	141,8	151,3	-	-	-	-	1,88	2,54	3,54	4,20
09	WP/WS/(WS)EM	LP	160	196,2	216	258,3	102,2	111,7	-	-	-	-	1,08	1,72	1,73	2,29
10	PV	LP	144	179,5	184	225	100,5	110	22,5	36,15	67,5	81,2	1,06	1,72	1,69	2,28
11	EF	LP	144,5	183	185	232	100,5	110	22,5	36,15	74,5	88,2	0,88	1,72	1,53	2,29
13	LPKF	LP	153	191,5	204	249	113	122,5	-	-	-	-	0,93	1,91	1,65	2,36
13	WSLPKF	LP	153	191,5	204	249	113	122,5	-	-	-	-	1,54	2,92	2,85	3,43
14	LI	LP	153	191,5	204	249	113	122,5	-	-	-	-	0,94	1,92	1,66	2,37
14	WSLI	LP	153	191,5	204	249	113	122,5	-	-	-	-	1,55	2,53	2,86	3,57

⁽¹⁾ Including coil(s) and connector(s).

ACCESSORIES

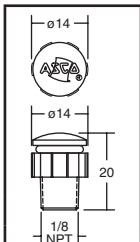

Pilot exhaust protector
part no.
276-405-001

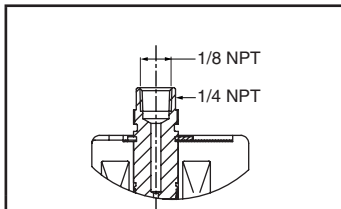

Pilot top exhaust low power
(ASCO solenoid interface)

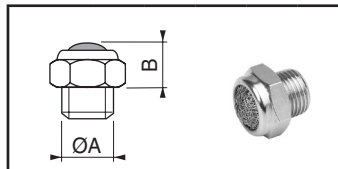

ØA	M5	1/8	1/4	3/8	1/2
B	4,5	10	11	11	14

exhaust protector
(stainless steel)